

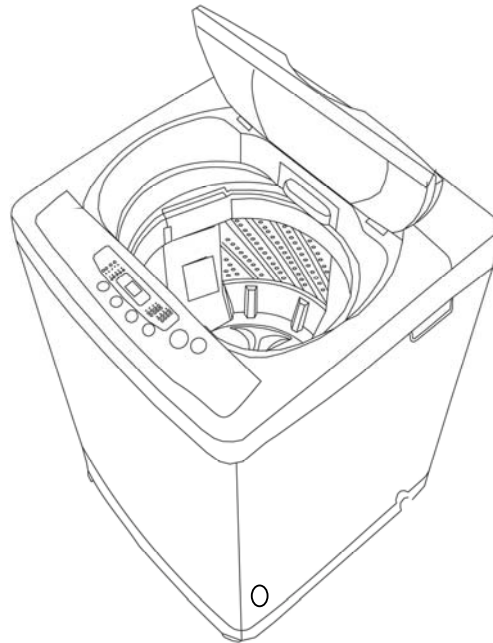

**INSTRUCTION MANUAL
MANUAL DE INSTRUCCIONES**

Model Numbers/ No. de Modelos: W757-1 / W758PS-1

**PORTABLE WASHER
LAVADORA PORTATIL**



BEFORE USE, PLEASE READ AND FOLLOW ALL SAFETY RULES AND OPERATING INSTRUCTIONS.

La sección en español empieza en la página 23.

Avanti has a policy of continuous improvement on its products and reserves the right to change materials and specifications without notice.

Avanti Products, A Division of the Mackle Co., Inc.
P.O. Box 520604 - Miami, Florida 33152
www.avantiproducts.com

TABLE OF CONTENTS

Appliance Safety	4
Important Safeguides	5
Help Us Help You / If You Need Service	6
Parts, Features, and Accessories	7
Important Safety Instructions	8
Installation Instructions	9
Before Using Your Portable Washer	9
Selecting a Location	9
Adjusting the Adjustable Foot	10
Installing the Noise Damper Plate	10
Connecting the Water Supply Hoses / Sink Faucet Connection	11 – 12
Disconnecting the Water Supply Hoses / Positioning the Drain Hose	12
Electrical Connection / Extension Cords	13
Control Panel / Functions Description	14
Operation Your Portable Washer	15
Preparation / Before Washing	15 – 16
Operating Instructions	17
Manual Function (Custom Washing Cycle) /Automatic Wash Program	17 – 18
Wash Program Time Chart	18 – 19
Delayed Start (Preset) Setting / Child-Proof Setting	19
Care and Maintenance	20
Problems with Your Portable Washer	21
Troubleshooting Guide / Service for Your Portable Washer	21
Your Avanti Products Warranty / What is not Covered	22
Instrucciones en Español	23 – 30
Registration Information and Registration Card	31

APPLIANCE SAFETY

Your safety and the safety of others are very important.

We have provided many important safety messages in this manual and on your appliance. Always read and obey all safety messages.



This is the Safety Alert Symbol. This symbol alerts you to potential hazards that can kill or injure you and others. All safety messages will follow the Safety Alert Symbol and either the words "DANGER", "WARNING" or "CAUTION".



Danger means that failure to heed this safety statement may result in severe personal injury or death.



Warning means that failure to heed this safety statement may result in extensive product damage, serious personal injury, or death.



Caution means that failure to heed this safety statement may result in minor or moderate personal injury, or property or equipment damage.

All safety messages will alert you do what the potential hazard is, tell you how to reduce the chance of injury, and let you know what can happen if the instructions are not followed.

IMPORTANT SAFEGUIDES



Before the appliance is used, it must be properly positioned and installed as described in this manual, so read the manual carefully. To reduce the risk of fire, electrical shock or injury when using the appliance, follow basic precaution, including the following:

DANGER

- Plug into a grounded 3-prong outlet, do not remove grounding prong, do not use an adapter, and do not use an extension cord.
- Replace all panels before operating.
- It is recommended that a separate circuit, serving only your appliance be provided. Use receptacles that cannot be turned off by a switch or pull chain.
- Never clean appliance parts with flammable fluids. These fumes can create a fire hazard or explosion. And do not store or use gasoline or other flammable vapors and liquids in the vicinity of this or any other appliance. The fumes can create a fire hazard or explosion.
- Before proceeding with cleaning and maintenance operations, make sure the power line of the unit is disconnected.
- Do not connect or disconnect the electric plug when your hands are wet.
- Unplug the appliance or disconnect power before cleaning or servicing. Failure to do so can result in electrical shock or death.
- Do not attempt to repair or replace any part of your appliance unless it is specifically recommended in this material. All other servicing should be referred to a qualified technician.

WARNING

FOLLOW WARNING CALL OUTS BELOW ONLY WHEN APPLICABLE TO YOUR MODEL

- Use two or more people to move and install appliance. Failure to do so can result in back or other injury.
- To ensure proper ventilation for your appliance, the front of the unit must be completely unobstructed. Choose a well-ventilated area with temperatures above 60°F (16°C) and below 90°F (32°C). This unit must be installed in an area protected from the element, such as wind, rain, water spray or drips.
- The appliance should not be located next to ovens, grills or other sources of high heat.
- The appliance must be installed with all electrical, water and drain connections in accordance with state and local codes. A standard electrical supply (110~127V AC only, 60 Hz), properly grounded in accordance with the National Electrical Code and local codes and ordinances is required.
- Do not kink or pinch the power supply cord of appliance.
- The fuse (or circuit breaker) size should be 15 amperes.
- It is important for the appliance to be leveled in order to work properly. You may need to make several adjustments to level it.
- Never allow children to operate, play with or crawl inside the appliance.
- Do not use solvent-based cleaning agents or abrasives on the interior. These cleaners may damage or discolor the interior.
- Do not use this apparatus for other than its intended purpose.

HELP US HELP YOU...

Read this guide carefully.

It is intended to help you operate and maintain your new portable washer properly.

Keep it handy to answer your questions. If you don't understand something or you need more assistance, please call:

Avanti Customer Service
800-220-5570

Keep proof of original purchase date (such as your sales slip) with this guide to establish the warranty period.

Write down the model and serial numbers.

You'll find them on a plate located on the rear outside wall of the portable washer.

Please write these numbers here:

Date of Purchase

Model Number

Serial Number

Use these numbers in any correspondence or service calls concerning your portable washer.

If you received a damaged portable washer, immediately contact the dealer (or builder) that sold you the portable washer.

Save time and money. Before you call for service, check the Troubleshooting Guide. It lists causes of minor operating problems that you can correct yourself.

IF YOU NEED SERVICE

We're proud of our service and want you to be pleased. If for some reason you are not happy with the service you receive, here are some steps to follow for further assistance.

FIRST, contact the people who serviced your portable washer. Explain why you are not pleased. In most cases, this will solve the problem.

NEXT, if you are still not pleased, write all the details, including your telephone number, and send it to:



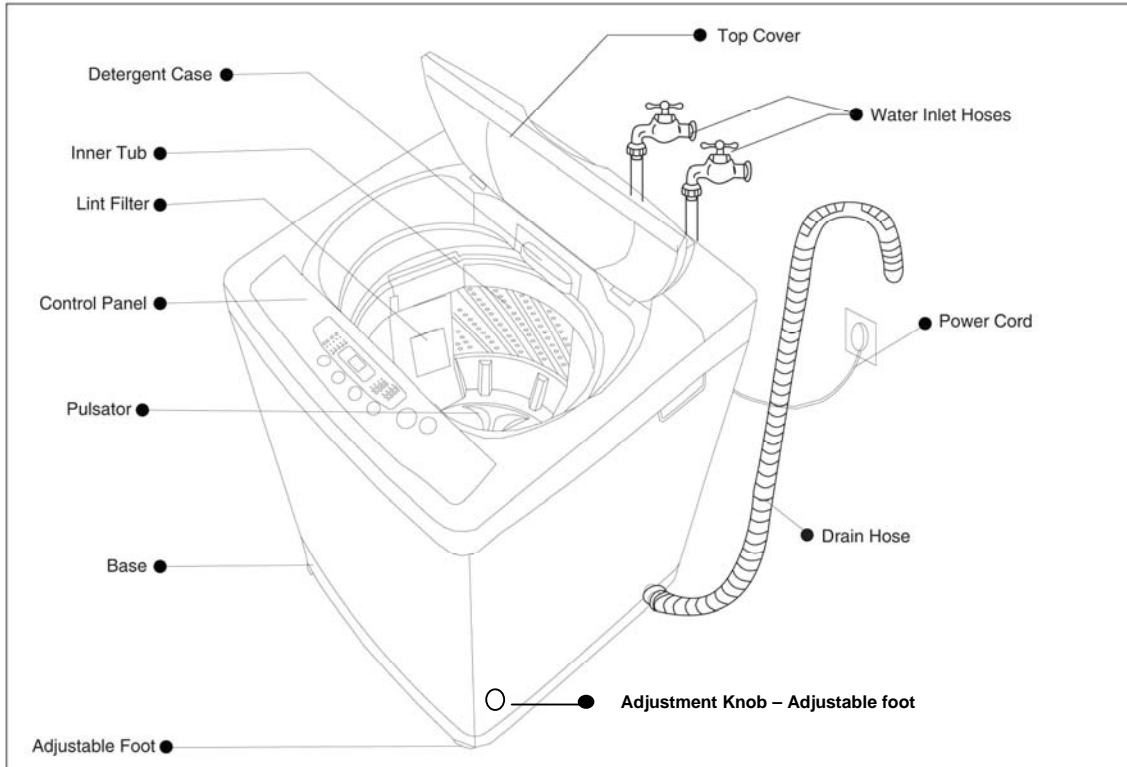

Customer Service
Avanti Products
10880 NW 30 Street
Miami, FL 33172 USA

PARTS & FEATURES

Models:	W757-1	Color: White
	W758PS	Color: Platinum
Capacity:	Cubic Feet: 1.65	Pounds: 12 Lbs.

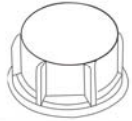

ACCESSORIES (INCLUDED)

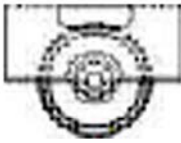
Instruction Manual	Hot Water Connector Lid	Faucet Adapter
		
1 Piece	1 Piece	2 Pieces
Rubber Washer	Water Inlet Hose	Caster
		
2 Pieces	2 Pieces	4 Pieces

IMPORTANT SAFETY INSTRUCTIONS

⚠WARNING⚠	To reduce the risk of fire, electrical shock, or injury when using your portable washer, follow these basic precautions:
<ul style="list-style-type: none"> • Read all instructions before using the portable washer. • Do not wash articles that have been previously cleaned in, washed in, soaked in, or spotted with gasoline, dry-cleaning solvents, or other flammable or explosive substances, as they give off vapors that could ignite or explode. • Do not add gasoline, dry-cleaning solvents, or other flammable or explosive substances to the wash water. These substances give off vapours that could ignite or explode. • Under certain conditions, hydrogen gas may be produced in a hot-water system that has not been used for 2 weeks or more. HYDROGEN GAS IS EXPLOSIVE. If the hot-water system has not been used for such a period, before using a washing machine, turn on all hot-water faucets and let water flow from each for several minutes. This will release any accumulated hydrogen gas. As the gas is flammable, do not smoke or use an open flame during this time. • DANGER or WARNING: Risk of child entrapment. Child entrapment and suffocation are not problems of the past. Junked or abandoned appliances are still dangerous . . . even if they will “just sit in the garage a few days.” • Before you throw away your old portable washer: Take off the lid. • Never allow children to operate, play with, or crawl inside the portable washer. Close supervision of children is necessary when the washer is used near children. • Do not reach into the washer if the agitator or inner tub is moving. • Do not tamper with controls. • Do not repair or replace any part of the washer or attempt any servicing unless specifically recommended in the user-maintenance instructions or in published user-repair instructions. • Never clean portable washer parts with flammable fluids. The fumes can create a fire hazard or explosion. • Do not place the washer in steamy rooms or where the washer is directly exposed to rain. Moisture may destroy the electrical insulation causing an electrical shock hazard. • Do not store, use gasoline, or any other flammable vapors and liquids in the vicinity of this or any other portable washer. The fumes can create a fire hazard or explosion. • If the power cord is damaged, it must be replaced by the manufacturer or its service agent or a similar qualified person in order to avoid a hazard. <p style="text-align: center;">-Save these instructions-</p>	



This appliance is not intended for use by persons (including children) with reduced physical, sensory, or mental capabilities.

This appliance should not be operated by those with a lack of experience or knowledge of its use or operation, unless they have been given instructions concerning and/or are supervised during the use of the appliance by a person responsible for their safety.

This appliance is not intended for use by children. To avoid any possible type of injury or damage to the unit and or personal property all children should be supervised to ensure they do not play with the appliance.

INSTALLATION INSTRUCTIONS

BEFORE USING YOUR PORTABLE WASHER

- Remove the exterior and interior packing.
- You will need the following tools:
 - Wrench
 - Pliers
 - Screwdriver
- Check to be sure you have all of the following parts:
 - 2 Inlet Hoses
 - 2 Faucet Adapters
 - 1 Noise Proof Plate With Screws
 - 4 Rubber Washers
 - 4 Casters
- Remove shipping brace. Note - It should be saved and used (to prevent damage to washer components) whenever washer is moved or transported to a new location.
- Clean the interior surface with lukewarm water using a soft cloth.
- Allow 2 inches of space between the back and sides of the appliance.
- Put your laundry into the washer evenly. Uneven laundry may cause noise or vibration.
- DO NOT use excessively hot water (122°F / 50°C or more). Plastic parts may be deformed or damaged. Also, clothing may be deformed or bleached.
- Before washing, check all pockets. If nails or pins remain in pockets, they may damage the washer or clothes.
- Never splash water on the control panel.
- Plug the washer into an exclusive properly installed-grounded wall outlet. Do not under any circumstances cut or remove the third (ground) prong from the power cord. Any questions concerning power and/or grounding should be directed toward a certified electrician or an Authorized Avanti Products service center.

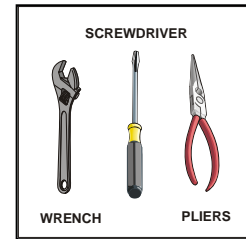

SELECTING A LOCATION

Before you install the portable washer, select a location with the following characteristics:

- A hard level surface (if the surface is uneven, see Adjusting The Adjustable Foot section on the next page).
- Away from direct sunlight. Direct sunlight may affect the acrylic coating plastic and electrical components.
- Adequate ventilation.
- Away from sources of heat such as coal or gas. Make sure that the washing machine does not stand on its power cord.
- Ventilation openings must not be obstructed by carpeting when the portable washer is installed on a carpeted floor. It is recommended that you place your portable washer on a hard material floor such as tile, concrete, linoleum and to avoid if at all possible placement on wooden floors or carpeted areas.

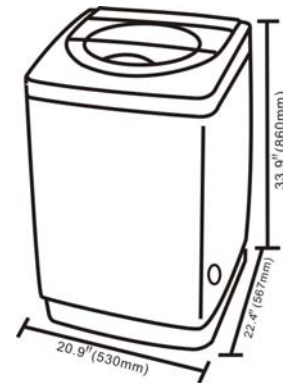

ADJUSTING THE ADJUSTABLE FOOT / SAFETY STOPPER

For a more efficient use of your portable washer it must be located on a level hard – stable surface.

If the floor is uneven adjust the adjustable foot (do not insert pieces of wood, or any other objects under the feet).

Place the washer on a sturdy flat surface.

Lower (Loosen) the adjustable foot by turning the level adjustable knob by hand until it is at the desired height.

Raise (Tighten) the adjustable foot by turning the level adjustable knob in the reverse direction.

If the washer is placed on an uneven or weak surface, noise or vibration occurs (Allowable is 1°).

For portable applications, the washing machine comes equipped with four (4) single direction casters that can easily be installed to assist in the movement of the machine to and from the sink.

- Lay the unit on its back.
- Install the casters into the bottom of the base as indicated in the figure shown on the right.
- Return the machine to the upright position.
- When the machine is positioned for operation/use set the height of the adjustment foot / safety stopper slightly higher than the front caster to prevent movement of the machine during wash and spin operation.

NOTE: *Not all movement will be totally eliminated, this is normal.*

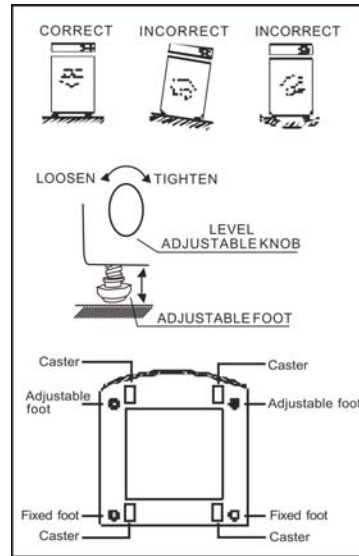

INSTALLING THE NOISE DAMPER PLATE

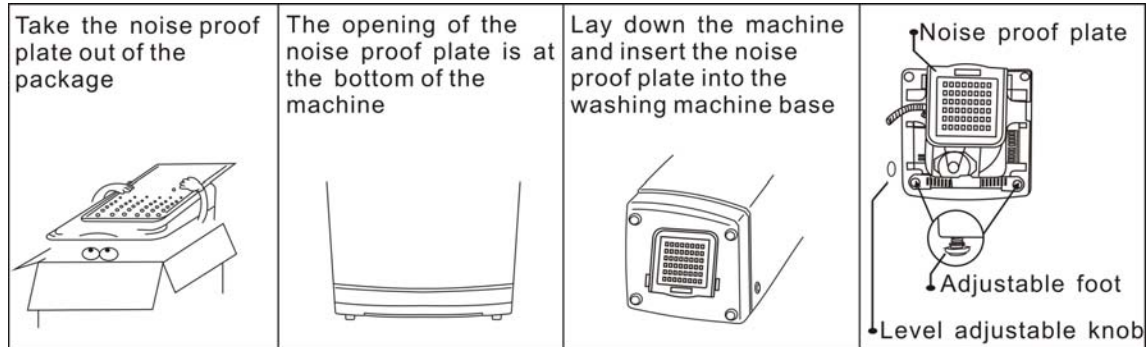

CONNECTING THE WATER SUPPLY HOSES

The water supply hose must be connected to the washing machine at one end and to the water faucet at the other. Do not stretch the water supply hose. If the hose is too short and you do not wish to move the water faucet, replace the hose with a longer, high-pressure hose.

Select appropriate faucet as shown in the figures below. If none of these faucets are available, use the faucet adapter provided.

The end of faucet spout should be longer than 10mm (0.4”), or the connector cannot be fixed properly. Water leakage could develop.

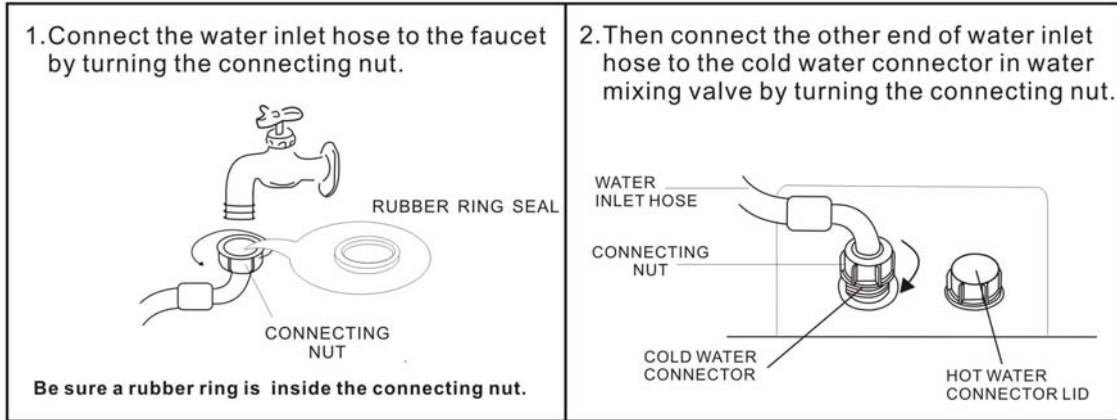

Note: The Hot Water Connector Lid is inside the accessories bag;
If only cold water is supplied, take the Hot Water Connector Lid from the accessories bag and screw it onto the “Hot Water Connector”

If you have both cold and hot water supplied, connect the inlet hoses by matching cold to cold and hot to hot.

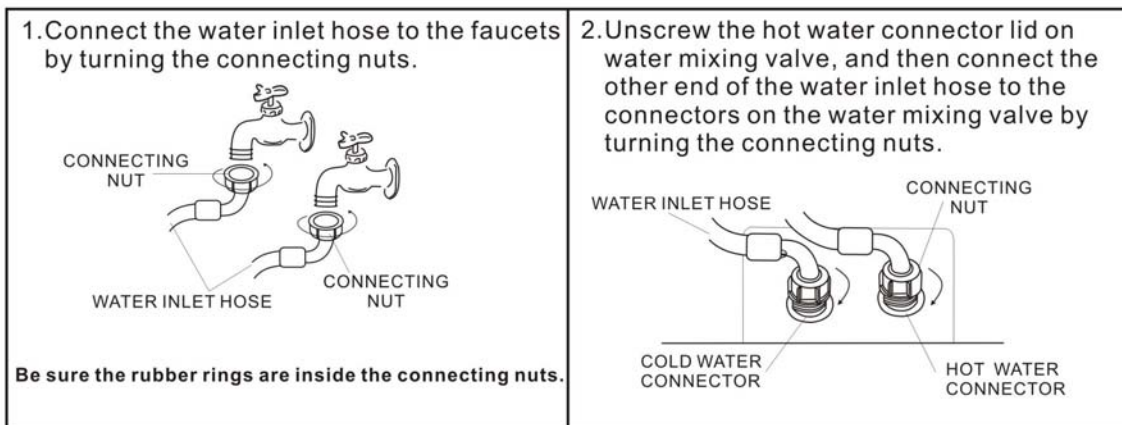

SINK FAUCET CONNECTION

For normal kitchen-sink tap only use the inlet hose with cold water inlet.

Connect the inlet hose to the male hose thread adapter by turning it clockwise to be fixed tightly.

Make sure to insert the rubber ring enclosed. Then connect tightly to your sink.

Note: Some faucets may require you to also use the female hose thread adapter between the male adapter and your sink faucet as shown below. Make sure the rubber ring is inserted and connect to your sink.

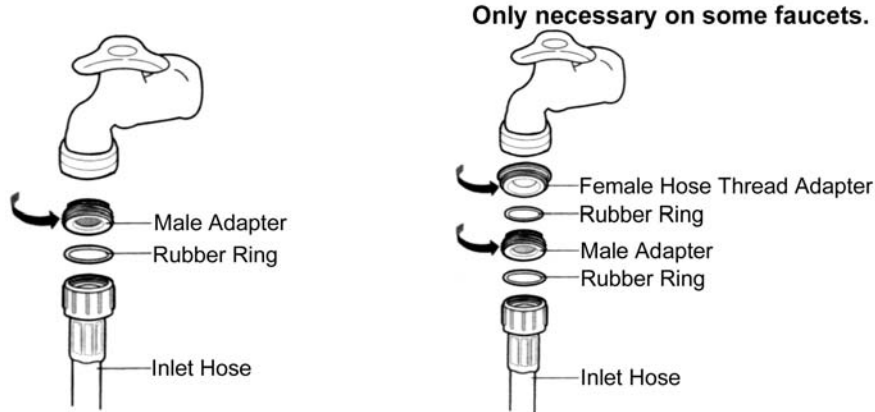

If water leaks from faucet connection or washer connection, turn off water and tighten fully using a wrench. Be careful not to overtighten and damage water connection. Turn on water supply and make sure no leaks are present.

DISCONNECTING THE WATER SUPPLY HOSES

Dismantling the hose directly may cause water to splash due to the possible high water pressure in the hose, even after the faucet has been turned off. Please take off the hose as per following steps, even if the faucet is closed:

- Turn off the faucet.
- Turn on the power and let the machine run for about 5 seconds then turn it off.
- Remove the connecting nuts from the faucet and washing machine.

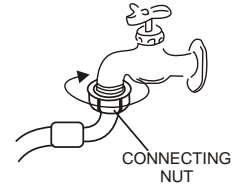

Note: If the washing machine is frequently used, it is not necessary to dismantle the inlet hose to avoid possible damage to the screws.

POSITIONING THE DRAIN HOSE

Connect the drain hose to the water outlet of the washing machine then fasten it with a cable tie. Since only up drainage is available, drain hose can be hung in the basin or bathtub.

NOTE: The highest point of the drain hose must be in the height of 2 ¼ – 4 feet above floor level, otherwise, the washer cannot work normally.

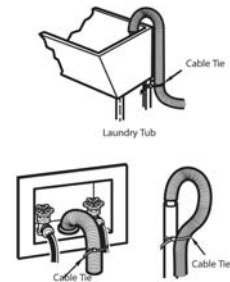

➤ **ELECTRICAL CONNECTION**

⚡ Warning ⚡

Improper use of the grounded plug can result in the risk of electrical shock. If the power cord is damaged, have it replaced by an authorized Avanti Products service center.

This appliance should be properly grounded for your safety. The power cord of this appliance is equipped with a three-prong plug which mates with standard three prong wall outlets to minimize the possibility of electrical shock.

Do not under any circumstances cut or remove the third ground prong from the power cord supplied. For personal safety, this appliance must be properly grounded.

This appliance requires a standard 110~127 Volt AC ~/60Hz electrical ground outlet with three-prong. Have the wall outlet and circuit checked by a qualified electrician to make sure the outlet is properly grounded. When a standard 2-prong wall outlet is encountered, it is your responsibility and obligation to have it replaced with a properly grounded 3-prong wall outlet.

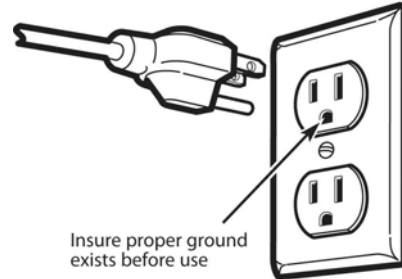

The cord should be secured behind the appliance and not left exposed or dangling to prevent accidental injury.

The appliance should always be plugged into its own individual electrical outlet which has a voltage rating that matches the rating label on the appliance. This provides the best performance and also prevent overloading house wiring circuits that could cause a fire hazard from overheated. Never unplug the appliance by pulling the power cord. Always grip the plug firmly and pull straight out from the receptacle. Repair or replace immediately all power cords that have become frayed or otherwise damaged. Do not use a cord that shows cracks or abrasion damage along its length or at either end. When moving the appliance, be careful not to damage the power cord.

➤ **EXTENSION CORD**

Because of potential safety hazards under certain conditions, it is strongly recommended that you do not use an extension cord with this appliance. However, if you must use an extension cord it is absolutely necessary that it be a UL/CUL-Listed, 3-wire grounding type appliance extension cord having a grounding type plug and outlet and that the electrical rating of the cord be 115 volts and at least 10 amperes.

➤ **SURGE PROTECTOR**

Most electrical appliances use a series of electric control boards to operate. These boards are very susceptible to power surges and could be damaged or destroyed.

If the appliance is going to be used in an area or if your city / country is prone to power surges / outages; it is suggested that you use a power surge protector for all electrical devices / appliances you use. The surge protector that you select must have a surge block high enough to protect the appliance it is connected to. If you have any questions regarding the type and size of surge protector needed contact a licensed electrician in your area.





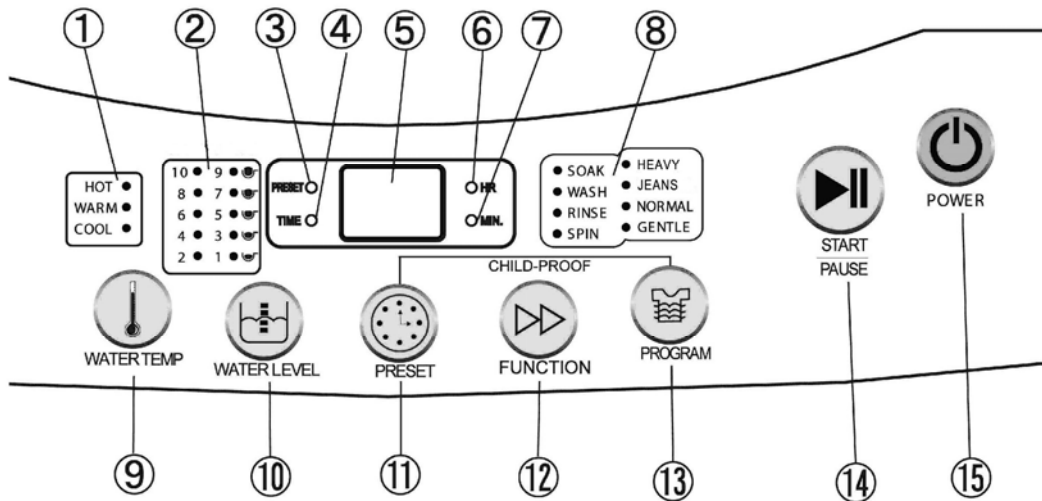

Damages due to power surges are not considered a manufacturer covered defect and will void your product warranty.

CONTROL PANEL

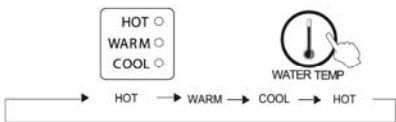

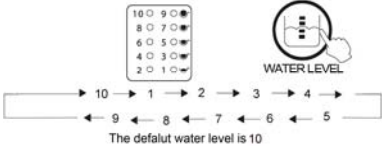

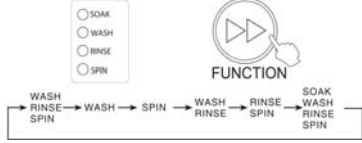
- | | |
|--------------------------------|--|
| 1. Water Temperature Indicator | 9. Water Temperature Selection Button |
| 2. Water Level Indicator | 10. Water Level Selection Button |
| 3. Delay Time Indicator | 11. Delay Selection Button |
| 4. Wash Time Indicator | 12. Function Selection Button |
| 5. LED Display | 13. Program (Automatic) Selection Button |
| 6. Hour Indicator | 14. Start / Pause Button |
| 7. Minute Indicator | 15. Power ON / OFF Button |
| 8. Function Indicator | |

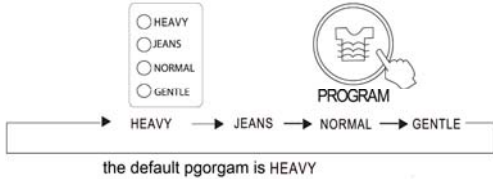
FUNCTION DESCRIPTIONS

9	 WATER TEMP	
10	 WATER LEVEL	 <p>The default water level is 10</p>
12	 FUNCTION	
13	 PROGRAM	 <p>the default program is HEAVY</p>

OPERATING YOUR PORTABLE WASHER

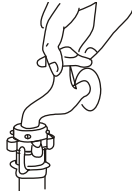
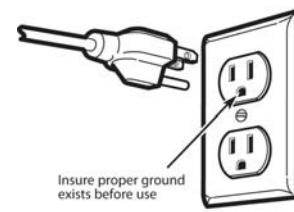
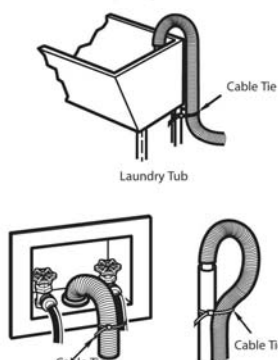
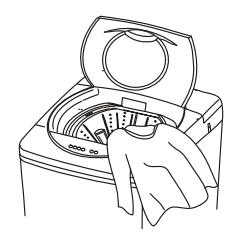
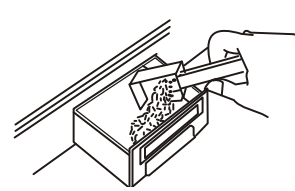
PREPARATION

<p>1. Connect the water inlet hose to the water faucet. Don't switch on the power if the water pressure is lower than 0.05MPa and higher than 0.5MPa.</p> <p>2. Open the water faucet.</p> 	<p>3. Insert the plug into the socket. For safety the plug should have ground connection.</p> 	<p>4. Insert the end of drain hose into the hook shelf, and hang the drain hose over a drain outlet.</p> 
<p>5. Put the wash load into the tub evenly.</p> 	<p>6. Add the suitable quantity detergent into the detergent case.</p> 	<p>7. Close the lid. Otherwise the washer will not wash or spin, and alarm will sound.</p> 

BEFORE WASHING

Prepare the wash load. Mix large and small articles in a load to get the best washing results. Drop articles loosely into the inner tub. Do not pack articles in or wrap them. Articles should move freely through the wash water for best cleaning results. Articles should rollover, sink and then reappear.

When washing very large articles, do not fill inner tub as full as with other loads. The water level in your washer should fit the size of your wash load. Small load will use lower water levels. There must be enough water in the inner tub to allow articles to move and turn over freely. Overloading the inner tub can result in poor washing and rinsing. Overloading may also cause wrinkling and tearing of articles.



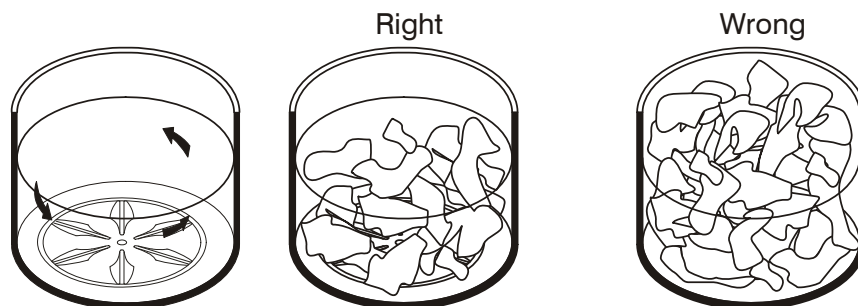





































WATER LEVEL



BEFORE WASHING

Make sure that you follow all manufacturer instructions for washing:

GUIDE TO APPAREL/TEXTILE CARE SYMBOLS

 Wash	<p>Machine Wash Cycles</p> <div style="display: flex; justify-content: space-around; align-items: center;"> <div style="text-align: center;">  Normal </div> <div style="text-align: center;">  Permanent Press </div> <div style="text-align: center;">  Delicate/ Gentle </div> </div> <p>Hand Wash</p> <div style="text-align: center;">  </div>	<p>Warning Symbols for Laundering</p> <div style="text-align: center;">  Do Not Wash </div> <div style="text-align: center;">  Do Not Bleach </div> <div style="text-align: center;">  Do Not Dry (used with Do Not Wash) </div> <div style="text-align: center;">  Do Not Iron </div>
 Bleach	<div style="display: flex; justify-content: space-around; align-items: center;"> <div style="text-align: center;">  Any Bleach When Needed </div> <div style="text-align: center;">  Only Non-Chlorine Bleach When Needed </div> </div>	
 Dry	<p>Tumble Dry Cycles</p> <div style="display: flex; justify-content: space-around; align-items: center;"> <div style="text-align: center;">  Normal </div> <div style="text-align: center;">  Permanent Press </div> <div style="text-align: center;">  Delicate/ Gentle </div> </div> <p>Line Dry / Hang to Dry</p> <div style="text-align: center;">  </div> <p>Tumble Heat Settings</p> <div style="display: flex; justify-content: space-around; align-items: center;"> <div style="text-align: center;">  Any Heat </div> <div style="text-align: center;">  High </div> <div style="text-align: center;">  Medium </div> <div style="text-align: center;">  Low </div> <div style="text-align: center;">  No Heat/Air </div> </div> <p>Drip Dry</p> <div style="text-align: center;">  </div> <p>Dry Flat</p> <div style="text-align: center;">  </div>	<p>Additional Instructions (in Symbols or Words)</p> <div style="text-align: center;">  Do Not Wring </div> <div style="text-align: center;">  Do Not Tumble Dry </div> <div style="text-align: center;">  In the shade (added to line dry, drip dry, or dry flat) </div> <div style="text-align: center;">  No Steam (added to iron) </div>
 Iron	<p>Iron-Dry or Steam</p> <div style="display: flex; justify-content: space-around; align-items: center;"> <div style="text-align: center;">  200C (390F) High </div> <div style="text-align: center;">  150C (300F) Medium </div> <div style="text-align: center;">  110C (230F) Low </div> </div> <p>Maximum Temperatures</p>	
 Dryclean	<p>Dryclean - Normal Cycle</p> <div style="display: flex; justify-content: space-around; align-items: center;"> <div style="text-align: center;">  Any Solvent </div> <div style="text-align: center;">  Any Solvent Except Trichloroethylene </div> <div style="text-align: center;">  Petroleum Solvent Only </div> </div> <p>Do Not Dryclean</p> <div style="text-align: center;">  </div>	<p>Dryclean - Additional Instructions</p> <div style="display: flex; justify-content: space-around; align-items: center;"> <div style="text-align: center;">  Short Cycle </div> <div style="text-align: center;">  Reduced Moisture </div> <div style="text-align: center;">  Low Heat </div> <div style="text-align: center;">  No Steam Finishing </div> </div>

OPERATING INSTRUCTIONS

PRESS THE POWER BUTTON.

PRESS THE WATER LEVEL BUTTON.

Choose appropriate water level according to wash load quantity.

WATER TEMPERATURE CHOICE.

Press the water temperature selection button, you can choose to from cold, warm, and/or hot water.

NOTE: The washer will provide a cold rinse in all TEMPERATURE settings.

Indicator Light Shown	Description
COOL	This means that you have selected to use COOL or cold water. The washing machine will only use water supplied by the cold water inlet.
HOT	This means that you have selected to use HOT water. The washing machine will only use water supplied by the HOT water inlet.
WARM	This means that you have selected to use WARM water. The washing machine will use water supplied by both the COLD and HOT water inlets simultaneously.

IMPORTANT: A single cold hose system does not allow the washing machine to automatically (select) regulate incoming water temperatures to match those listed on the control panel such as WARM or HOT.

PRESS THE FUNCTIONS SELECTION BUTTON.

Choose the desired function and then the corresponding indicator blink.

PRESS DOWN START/PAUSE BUTTON ONCE AND THE MACHINE WILL BEGIN OPERATION.

Please press this button to stop the normal operation, if it continues to work, press it again.

Water level can be reset during the normal operation. If the higher water level is selected, the machine will operate after refilling the water level selected.

MANUAL FUNCTIONS SELECTION (CUSTOM WASHING CYCLE)

SOAK – For dirty laundry

- Press down the power button.
- Press the function button until the SOAK indicator is ON.
- Press the water temp button to select the water temperature.
- Press the water level button to select the appropriate water level setting.
- Press the START/PAUSE to start the course. And the LED display will show the remaining time of the entire course.

WASH ONLY

- Press down the power button.
- Press the function button to until only the WASH indicator is ON.
- Press the water temp button to select the water temperature.
- Press the water level button to select the appropriate water level setting.
- Press the START/PAUSE to start the course. And the LED display will show the remaining time of the entire course.

WASH AND RINSE

- Press down the power button.
- Press the function button until the WASH & RINSE indicators are ON.
- Press the water temp button to select the water temperature.
- Press the water level button to select the appropriate water level setting.
- Press the START/PAUSE to start the course. And the LED display will show the remaining time of the entire course.

RINSE AND SPIN

- Press down the POWER button.
- Press the function button until the RINSE & SPIN indicators are ON.
- Press the water level button to select the appropriate water level setting.
- Press the START/PAUSE to start the course. And the LED display will show the remaining time of the entire course.

Note: At this function, the water temp can't be chosen, the default water temp is COOL.

SPIN ONLY

- Press down the power button.
- Press the function button to select the SPIN function until only SPIN indicator is ON.
- Press the START/PAUSE to start the course. And the LED display will show the remaining time of the entire course.

AUTOMATIC WASH PROGRAMS

HEAVY – For extremely dirty laundry

- Press down the power button.
- Press the program button to select the **HEAVY** program until the **HEAVY** indicator is ON. (HEAVY is the default program)
- Press the water temp button to select the water temperature.
- Press the water level button to select the appropriate water level setting. (The default water level is **10** water level)
- Press the START/PAUSE to start the course. And the LED display will show the remaining time of the entire course.

JEANS – For JEANS laundry

- Press the power button.
- Press the program button to select the **JEANS** program until the **JEANS** indicator is ON. Press the water temp button to select the water temperature.
- Press the water level button to select the appropriate water level setting.
- Press the START/PAUSE to start the course. And the LED display will show the remaining time of the entire course.

NORMAL – For normal laundry

- Press down the power button.
- Press the program button to select the NORMAL program until the NORMAL indicator is ON.
- Press the water temp button to select the water temperature.
- Press the water level button to select the appropriate water level setting.
- Press the START/PAUSE to start the course. And the LED display will show the remaining time of the entire course. (At the NORMAL program, SOAK function cannot be selected)

GENTLE – For delicate laundry

- Press down the power button.
- Press the program button to select the GENTLE program until the GENTLE indicator is ON.
- Press the water temp button to select the water temperature.
- Press the water level button to select the appropriate water level setting.
- Press the START/PAUSE to start the course. And the LED display will show the remaining time of the entire course.

WASH PROGRAM TIME CHART

Each wash program is pre-programmed in the computer; see the details for each in the wash program chart below:

FUNCTION	SOAK (Optional)	WASH	RINSE	SPIN	TOTAL TIME (Approx.)
HEAVY	5 Min	18 Min	2 Cycles	5 Min.	57 Min.
JEANS	5 Min	12 Min	2 Cycles	5 Min.	44 Min.
NORMAL		11 Min	1 Cycle	5.5 Min.	32Min.
GENTLE	5 Min	12 Min.	2 Cycles	3.5 Min.	43 Min.

Note: The default function is WASH, RINSE and SPIN, if you need the SOAK function, please press the function button to choose the SOAK function.

Close the lid, or the washing machine will buzz during wash and spin cycle.

In the event the clothing loaded becomes unbalanced, the safety switch will be triggered causing the washing machine to automatically refill with water to adjust the imbalance.

Note:

- Clothes easily discolored should be washed separately so as to prevent inter-dyeing.
- If you want to change a selected program, please press the START/PAUSE button first, then press the Program button before pushing START/PAUSE button.
- When the Rinse and Spin functions are ON, do not use detergent.
- If you want to drain water during washing, press the START/PAUSE button, then select the Rinse program. Press START/PAUSE button again to restart.

DELAY START (PRESET) SETTING

Select this option when you would like to load the washer but not run the wash cycle until a later time.

Note:

As washing machines and other appliances are considered to present a potential child entrapment danger; you should never run a wash cycle when you are not present for either the entire or major portion of the cycle.

- Press down the power button.
- Load the washing machine and select the appropriate wash program.
- Press PRESET button continuously to select the delay start time. (From 1 hour to 24 hours)
- Close the lid completely.
- Press START/PAUSE button to start the course.

CHILD-PROOF SETTING

Your washing machine is equipped with a child safety setting that will once activated sound an alarm and drain the wash water in the event the lid is opened during operation.

If after the child safety setting is activated, the lid is opened during operation a loud alarm will sound.

If the lid is not closed within 10 seconds, the wash water will be drained automatically.

If you have small children, it is recommended that you activate this setting every time you use the washing machine as children can be attracted to and enticed to play with the washing machine.

- Select the desired washing program as described previously in this manual
- Select the appropriate program and press START/PAUSE button to start the washing machine.
- Press and hold both the PRESET and PROGRAM buttons together to activate the Child-Proof Lock. The digital indicator will show  and the remaining wash time.

Note:

When set up Child-Proof Lock, if the lid is opened while the machine is running, all operations will be stopped immediately and an alarm will sound, and will automatically drain all water if the lid is not closed in 10 seconds. To resume operation, close the lid.

As a default when Child-Proof Lock is not activated, if you open the lid while the machine is running, all operations will be stopped within 10 seconds and will automatically drain water in 30 seconds and sound an alarm. To resume operation, close the lid.

Note:

As washing machines and other appliances are considered to present a potential child entrapment danger; you should never run a wash cycle when you are not present for either the entire or major portion of the cycle.

CARE AND MAINTENANCE

CLEANING YOUR PORTABLE WASHER

- Clean the surface of your portable washer regularly with soft fabric.
- Clean the inner tub regularly, especially immediately after starch or bleach operation.
- Clean the filter in the inlet valve or inlet hose regularly in order to prevent it from clogging.

1. #Kqsocj#kh#srzh#fngl

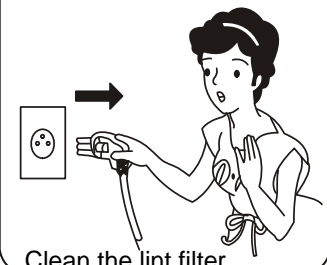

• Clean the lint filter.

2. Uhp ryl#kh#qow#rvh#og#fodg#
wh#lwn#lk#euvk1

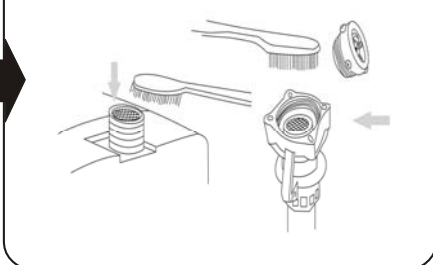

- Fodg#kh#xuidf#r#
wkh#dvk#lj#p d#k#l#
z lk#r#v#f#v#k#
unjxold#
- Fodg#kh#l#q#u#e#
unjxold#v#sh#f#d#s#n#
z dvk#lj#v#d#k#g#u#
ed#f#k#g#v#x#g#u#1

1. Sxoksz d#g#r#l#p ryl#kh#
d#v#l#n#1

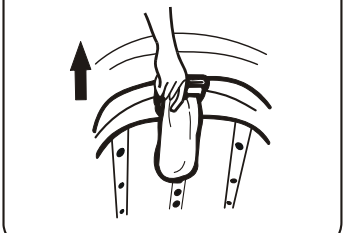

2. Fodg#og#l#v#h#k#r#u#x#k#d#1

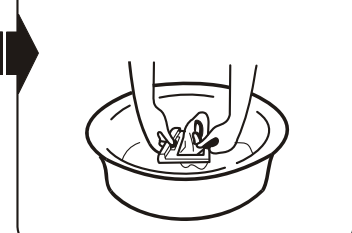

3. Reinstall.

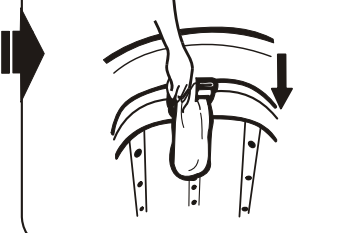

- Vacation time

1. Turn off the tap, remove water inlet hose, and let water drain out from the hose.

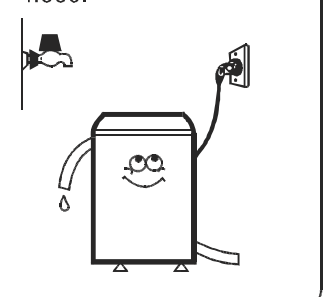

2. Set spin cycle for 1 minute.

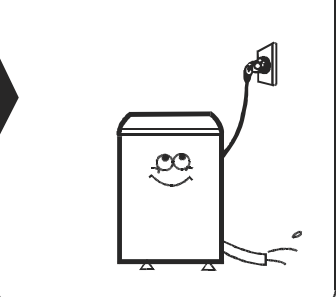

3. Unplug the power cord.

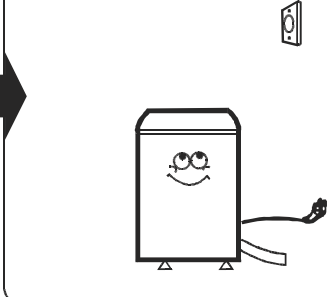

PROBLEMS WITH YOUR PORTABLE WASHER?

You can solve many common portable washer problems easily, saving you the cost of a possible service call. Try the suggestions below to see if you can solve the problem before calling the servicer.

TROUBLESHOOTING GUIDE

PROBLEM	POSSIBLE CAUSE
Washer does not operate.	Not plugged in. The circuit breaker tripped or a blown fuse. The lid is not closed. Make sure the water source is turned on.
No water or insufficient water supply.	The water source faucet is not turned on. The water source hose is frozen. The water intake hose is bent. The filter on the water intake hose is clogged.
The washing machine does not drain.	The drain hose is squashed or bent.
Washing machine vibrates or is too noisy.	Check to assure that the washer is level. The washing machine is touching another object. The laundry load is not balanced.
Washing machine does not spin.	The lid is not closed. The washer is not on a level surface.
Display shows Error Code "E 1" Description: Malfunction in the Water Supply Valve	No water, Water supply valve time-out, Water valve is clogged.
Display shows Error Code "E 2" Description: Malfunction in the Water Level	Water level exceeds limit of high or low water level.
Display shows Error Code "E 3" Description: Top Cover is Open	During operation the top is open. Close the top.
Display shows Error Code "E 4" Description: Unit is unbalanced	Unit becomes unbalanced during operation. Stop the unit, shift the load evenly, restart
Display shows Error Code "E 5" Description: Malfunction in the Drain Valve	Drain valve is clogged, Drain motor is not operating normally Drain time-out occurs.
Display shows Error Code "E 6" Description: Water Level Sensor	During the self – check procedure, the zero point error of the water level is too high.

SERVICE FOR YOUR PORTABLE WASHER

We are proud of our customer service organization and the network of professional service technicians that provide service on your Avanti portable washers. With the purchase of your Avanti portable washer, you can be confident that if you ever need additional information or assistance, the Avanti Products Customer Service Team will be here for you. Just call us toll-free.

AVANTI PRODUCTS CUSTOMER SERVICES

Product Information 800-323-5029	Whatever your questions are about our products, help is available.
Part Orders 800-220-5570	You may order parts and accessories that will be delivered directly to your home by personal check, money order, Master Card, or Visa.
In-Home Repair Service 800-220-5570	An Avanti Products authorized service center will provide expert repair service, scheduled at a time that is convenient for you. Our trained servicers know your portable washer inside and out.

YOUR AVANTI PRODUCTS WARRANTY	Staple your sales receipt here. Proof of original purchase date is needed to obtain service under warranty.
--------------------------------------	--

WHAT IS COVERED
LIMITED ONE-YEAR
WARRANTY

For one year from the date of purchase by the original owner, Avanti Products will, at its option, repair or replace any part of the appliance that proves to be defective in material or workmanship under normal use. Avanti Products will provide you with a reasonably similar replacement product that is either new or factory refurbished. During this period Avanti Products will provide all parts and labor necessary to correct such defects free of charge, so long as the appliance has been installed and operated in accordance with the written instructions in this manual. In rental or commercial use, the warranty period is 90 days.

LIMITED 5 YEAR WARRANTY ON PLASTIC TUB

After one year and until five years from date of purchase, Avanti will furnish a replacement plastic tub, which is defective in material or workmanship. You will be responsible for labor.

LIMITED 7 YEAR WARRANTY ON STAINLESS STEEL TUB

After one year and until seven years from date of purchase, Avanti will furnish a replacement stainless steel tub, which is defective in material or workmanship. You will be responsible for labor.

WHAT IS NOT COVERED

- Incidental or consequential damages.
- Service calls to:
- Correct the installation of your washer.
- Instruction on how to use your washer.
- Replace house fuses or incorrect house wiring or plumbing.
- Repairs performed by unauthorized servicers.
- Repairs when your washer is used in other than normal, single-family household use.
- Shipping and Handling costs associated with the replacement of the unit.
- Service calls that are related to external problems, such as abuse, misuse, inadequate electrical power, accidents, fire, floods, or acts of God.
- Surcharges including, but not limited to, any after hour, weekend, or holiday service calls, tolls, ferry trip charges, or mileage expense for service calls to remove areas, including the State of Alaska.
- Failure of the product if it is used for other than its intended purpose.
- Pickup and delivery.
- Repairs caused by unauthorized modifications made to the appliance.
- This warranty does not apply outside the Continental U.S.A.



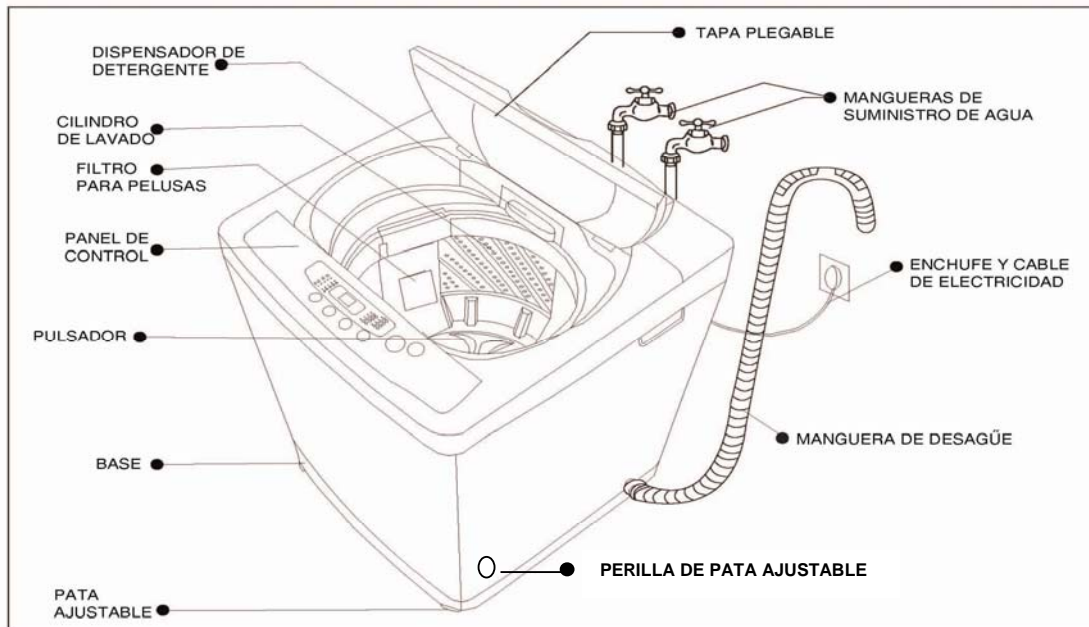

INSTRUCCIONES EN ESPAÑOL

LEA TODAS LAS INSTRUCCIONES ANTES DE USAR ESTA LAVADORA Y GUARDE ESTE MANUAL EN UN LUGAR SEGURO PARA REFERENCIA FUTURA.

Modelos:	W757-1	Color: Blanco
	W758PS	Color: Platinado
Capacidad:	Pies Cúbicos: 1.65	Libras: 12

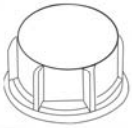

ACCESORIOS INCLUIDOS

Manual de Instrucciones	Tapa Del Connector De Agua Caliente	Adaptador de Grifo
		
1 pieza	1 pieza	2 piezas
Arandelas	Mangueras de Suministro de agua	Ruedas
		
2 piezas	2 piezas	4 piezas

Conexión Eléctrica

⚡ ADVERTENCIA ⚡

EL USO INAPROPIADO DEL ENCHUFE A TIERRA PUEDE OCASIONAR RIESGO DE UN CHOQUE ELECTRICO. SI EL CORDON SE DAÑASE, LLEVELO A UN CENTRO DE SERVICIO AUTORIZADO POR AVANTI PRODUCTS PARA QUE SE REEMPLACE.

- Para su seguridad, esta lavadora debe estar apropiadamente conectada a tierra. El cordón eléctrico de esta lavadora está equipado con un enchufe de tres puntas, el cual encaja perfectamente en los receptáculos/enchufes de pared de tres puntas estándar, para minimizar la posibilidad de un choque eléctrico.
- Bajo ninguna circunstancia corte o retire la tercera punta (cable a tierra) del enchufe del cordón eléctrico.
- Nunca use un cable de extensión para conectar la unidad a la electricidad.
- Nunca use un adaptado con enchufe de solo 2 puntas.
- Si solo puede conectar la lavadora a un receptáculo/enchufe de pared de 2 puntas, comuníquese con un electricista calificado para que reemplace ese receptáculo/enchufe de pared por uno de 3 puntas, de acuerdo con los códigos de electricidad aplicables.
- Esta lavadora requiere un receptáculo/enchufe de pared de tres puntas estándar de 110~127 voltios a.c.~/60hz.
- Para prevenir cualquier daño físico o lesión, el cordón debe ser asegurado detrás de la lavadora y no estar expuesto o colgando.

Cable de Extensión

Debido al posible riesgo de seguridad causado bajo ciertas circunstancias, se recomienda firmemente que no use un cable de extensión para este electrodoméstico. Sin embargo, si no tiene otra opción mas que usar un cable de extensión, asegúrese que este sea un cable de extensión para electrodomésticos que este listado bajo UL/CUL, que tenga enchufe y receptáculo para enchufe de tres puntas (cable a tierra) y que la capacidad del cordón eléctrico sea de 110~127 voltios y no menos de 10 amperios.

Protector contra variaciones de corriente eléctrica (Surge Protector).

La mayoría de electrodomésticos utilizan una series de paneles de control para operar. Estos paneles son muy susceptibles a las variaciones de corriente eléctrica, las cuales causan que estos se dañen o destruyen.

Si vive en un área o ciudad done hay muchas variaciones de corriente o apagones, se recomienda que utilice un protector contra variaciones de corriente para todos los electrodomésticos y aparatos eléctricos. El protector que elija debe bloquear una variación de electricidad alta para poder proteger el electrodoméstico al cual está conectado. Por favor contáctese con un electricista licenciado en su área si tuviera preguntas en referencia al tipo y tamaño de protector que necesita.

Daños debido a variaciones de electricidad no se consideran un defecto del fabricante y podrían anular la garantía.

ADVERTENCIA

SIGA ESTAS PRECAUCIONES BASICAS PARA REDUCIR EL RIESGO DE FUEGO, CORTO CIRCUITO O DAÑOS AL USAR SU LAVADORA PORTATIL.

- NO LIMPIE LA LAVADORA PORTATIL CON LIQUIDOS INFLAMABLES. EL VAPOR PUEDE CREAR FUEGO O UNA EXPLOSION
- LEA TODAS LAS INSTRUCCIONES ANTES DE USAR SU LAVADORA PORTATIL.
- RIESGOS DE QUE LOS NIÑOS QUEDEN ATRAPADOS DENTRO DE LOS EQUIPOS NO SON PROBLEMAS DEL PASADO, NO PERMITA QUE OPEREN, JUEGUEN O ENTREN DENTRO DE LA LAVADORA. ANTES DE BOTAR O RETIRAR SU LAVADORA ASEGURESE DE QUITARLE LA PUERTA.
- NO COLOQUE LA LAVADORA EN LUGARES HUMEDOS O EXPUESTA AL VAPOR O A LA LLUVIA. LA HUMEDAD PUEDE DESTRUIR EL AISLAMIENTO ELECTRICO, PUDIENDO CAUSAR UN CHOQUE ELECTRICO.
- NO ALMACENE, USE GASOLINA U OTRO LIQUIDO GAS INFLAMABLE CERCA DE ESTA U OTRA LAVADORA PORTATIL. EL VAPOR PUEDE CREAR FUEGO O UNA EXPLOSION.

INSTRUCCIONES DE INSTALACION

ANTES DE USAR SU LAVADORA

- REMUEVA EL EMPAQUE EXTERIOR E INTERIOR.
- NECESITARA LAS SIGUIENTES HERRAMIENTAS:
 - LLAVE INGLESA (O AJUSTABLE)
 - PINZAS (ALICATE)
 - DESTORNILLADOR
 - RUEDAS (TOTAL 4)

- ASEGURESE QUE TIENE LAS SIGUIENTES PIEZAS
 - 2 MANGUERAS CON ADAPTADORES PARA EL GRIFO
 - 1 PLACA PARA REDUCIR RUIDO
 - 4 ARRANDELAS DE GOMA
 - 1 MANUAL DE INSTRUCCIONES
 - 1 ADAPTADOR DE GRIFO

- REMUEVA EL PROTECTOR.
- NOTA: DEBE GUARDAR Y USARLO CUANDO TENGA QUE MOVER O TRANSPORTAR LA LAVADORA A OTRO LUGAR.
- LIMPIE EL INTERIOR CON UN TRAPO SUAVE Y AGUA TIBIA.
- DEJE 2 PULGADAS DE ESPACIO ENTRE LA PARED Y LA LAVADORA.
- COLOQUE SU ROPA EN LA LAVADORA UNIFORMEMENTE. ROPA DESNIVELADA EN LA LAVADORA, PODRIA CAUSAR RUIDO O VIBRACION.
- NO USE AGUA DEMASIADO CALIENTE (50°C Ó MAS) YA QUE LAS PARTES PLASTICAS PODRIAN DEFORMARSE O DAÑARSE Y LA ROPA PODRIA DEFORMARSE O DESTENIRSE.
- ANTES DE LAVAR, REVISE Y VACIE TODOS LOS BOLSILLOS. CLAVOS, ALFILERES, ETC. ESTOS OBJETOS PUEDEN DAÑAR LA LAVADORA O SU ROPA.
- NO SALPIQUE AGUA AL PANEL DE CONTROL.
- CONECTE LA LAVADORA A UN ENCHUFE DE PARED EXCLUSIVO, CON CONEXION A TIERRA. BAJO NINGUNA CIRCUNSTANCIA REMUEVA O CORTE LA TERCERA PUNTA DEL ENCHUFE (CONEXION A TIERRA). DIRIJA CUALQUIER PREGUNTA RELACIONADA CON LA ELECTRICIDAD O CONEXION A TIERRA A UN ELECTRICISTA CERTIFICADO O A UN CENTRO DE SERVICIO AUTORIZADO POR AVANTI.

SELECCIONE UN LUGAR

ANTES DE INSTALAR SU LAVADORA, SELECCIONE UN LUGAR CON LAS SIGUIENTES CARACTERISTICAS:

- SUPERFICIE PLANA Y DURA (SI LA SUPERFICIE ES IRREGULAR, VEA "AJUSTE DE PATAS NIVELADORAS").
- LEJOS DE LA LUZ SOLAR DIRECTA. LA LUZ SOLAR DIRECTA PUEDE AFECTAR LA CAPA ACRILICA, COMPONENTES PLASTICOS Y ELECTRICOS.

- VENTILACION ADECUADA.
- LEJOS DE LAS FUENTES DE CALOR TALES COMO CARBON O GAS.
- ASEGURESE QUE LA LAVADORA NO ESTE APLASTANDO EL CORDON ELECTRICO. LAS APERTURAS DE VENTILACION DEBEN ESTAR LIBRES DE OBSTRUCCIONES TALES COMO ALFOMBRA.

AJUSTE DE PATAS NIVELADORAS

SI EL PISO ES IRREGULAR, AJUSTE LAS PATAS (NO INSERTE PEDAZOS DE MADERA U OTROS OBJETOS BAJO LAS PATAS).

PARA BAJAR LA PATA AJUSTABLE GIRA LA PERILLA HACIA LA IZQUIERDA.

PARA SUBIR LA PATA AJUSTABLE GIRA LA PERILLA HACIA LA DERECHA.

COLOQUE LA LAVADORA EN UNA SUPERFICIE PLANA Y FIRME.

SI COLOCA LA LAVADORA EN UNA SUPERFICIE IRREGULAR O BLANDA, PODRIA CAUSAR DAÑO O VIBRACION.

PARA PORTABILIDAD, LA LAVADORA VIENE CON CUATRO RUEDAS FACILES DE INSTALAR, PARA AYUDAR AL MOVIMIENTO DE LA LAVADORA HACIA Y DESDE EL LAVADERO, ACUESTE LA UNIDAD SOBRE LA PARTE TRASERA E INSTALE LAS RUEDAS EN LA PARTE DE ABAJO DE LA BASE COMO MUESTRAN LAS FIGURAS, (DEBAJO EN ESTA PAGINA.)

REGRESE LA UNIDAD A LA POSICION VERTICAL. CUANDO LA MAQUINA ESTE COLOCADA PARA FUNCIONAMIENTO, AJUSTE LA PATA A UNA ALTURA UN POCO MAYOR A LAS RUEDAS PARA EVITAR QUE LA LAVADORA SE MUEVA DURANTE EL LAVADO.

NOTA: AUN HACIENDO LO ANTERIOR, LA LAVADORA PODRIA MOVERSE. ESTO ES NORMAL.

INSERTE LA BANDEJA A PRUEBA DE RUIDO EN LA BASE DE LA LAVADORA



REMOVIENDO EL PROTECTOR

PARA PREVENIR QUE LA LAVADORA SE DAÑE, RECOMENDAMOS QUE GUARDE EL PROTECTOR Y LO USE CUANDO NECESITE MOVER O TRANSPORTAR SU LAVADORA,

PANEL DE CONTROL

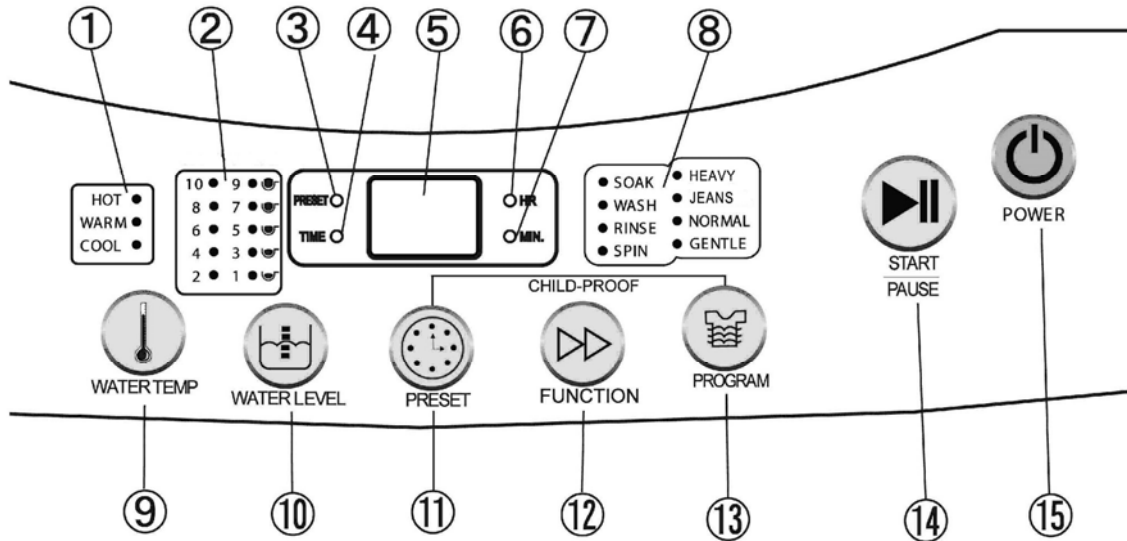

1. INDICADOR DE TEMPERATURA DEL AGUA
2. INDICADOR DEL NIVEL DE AGUA
3. INDICADOR DEL MODO DE LAVADO PRE-PROGRAMADO
4. INDICADOR DEL TIEMPO
5. PANTALLA ELECTRONICA
6. INDICADOR DE LA HORA
7. INDICADOR DE LOS MINUTOS
8. INDICADOR DE FUNCIONES
9. BOTON PARA SELECCIONAR LA TEMPERATURA DE AGUA
10. BOTON PARA SELECCIONAR EL NIVEL DE AGUA
11. BOTON PARA PROGRAMAR UN CICLO DE LAVADO
12. BOTON PARA SELECCIONAR LA FUNCION
13. BOTON PARA SELECCIONAR EL CICLO AUTOMATICO PRE-PROGRAMADO
14. BOTON PARA INICIAR O TERMINAR EL CICLO DE LAVADO
15. BOTON PARA PRENDER O APAGAR LA LAVADORA

CONECTANDO LA MANGUERA DE SUMINISTRO DE AGUA

UN EXTREMO DE LA MANGUERA PARA SUMINISTRO DE AGUA DEBE SER CONECTADO A LA LAVADORA Y EL OTRO EXTREMO AL GRIFO. NO ESTIRE LA MANGUERA DE SUMINISTRO DE AGUA. SI LA MANGUERA ES MUY CORTA Y NO DESEA MOVER EL GRIFO, REEMPLACE LA MANGUERA CON UNA MAS LARGA, DE ALTA PRESION.

SELECCIONE EL GRIFO ADECUADO TAL COMO SE MUESTRA EN LAS FIGURAS ABAJO. SI NINGUNO DE ESTOS GRIFOS ESTA DISPONIBLE, USE EL ADAPTADOR INCLUIDO.

EL LARGO DEL GRIFO DEBE SER DE MAS DE 10 MM (0.4"), DE OTRA MANERA EL CONECTOR NO PODRA SER AJUSTADO APROPIADAMENTE Y PODRIA PRODUCIR GOTEO.

IMPORTANTE: EN ESTA SITUACION, NO PROGRAME LA OPCION CALIENTE (HOT) COMO TEMPERATURA DE LAVADO.

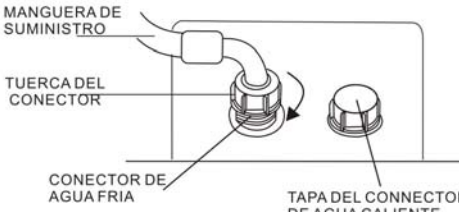
<p>1. CONECTE LA MANGUERA A EL GRIFO DE SUMINISTRO DE AGUA A LA LLAVE GIRANDO LA TUERCA DEL CONECTOR DE LA MANGUERA HACIA LA DERECHA.</p>  <p>ASEGURESE QUE EL ANILLO SELLADOR DE GOMA ESTE DENTRO DE LA TUERCA DEL CONECTOR DE LA MANGUERA.</p>	<p>2. REMUEVA LA TAPA DE EL CONECTOR DE AGUA FRIA Y CONECTE EL OTRO EXTREMO DE LA MANGUERA DE SUMINISTRO DE AGUA CONECTOR DE AGUA A EL FRIA EN LA VALVULA MEZCLADORA DE AGUA. GIRANDO LA TUERCA DEL CONECTOR HACIA LA DERECHA</p> 
---	--

Nota: La tapa del conector de agua caliente está en la bolsa plástica con los accesorios. Si solamente agua fría está disponible, tome la tapa del conector de agua caliente de la bolsa de accesorios y conéctela al conector de agua caliente

SI USTED TIENE LAS LLAVES DE SUMINISTRO DE AGUA POR SEPARADO (CALIENTE Y FRIA), CONECTE LA MANGUERA A LA LLAVE DE AGUA FRIA Y AL CONECTOR DE AGUA FRIA EN LA VALVULA MEZCLADORA DE AGUA. HAGA LO MISMO CON EL AGUA CALIENTE Y LA SEGUNDA MANGUERA.

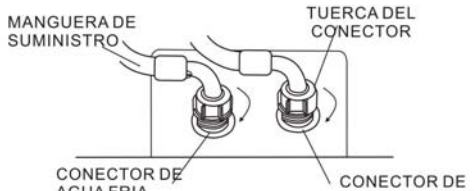
<p>1. CONECTE LAS MANGUERAS DE SUMINISTRO DE AGUA A LOS DRIFOS GIRANDO LAS TUERCAS DE LOS CONECTORES DE LAS MANGUERAS HACIA LA DERECHA</p>  <p>ASEGURESE DE COLOCAR EL ANILLO SELLADOR DENTRO DE LAS TUERCAS DE LOS CONECTORES DE LAS MANGUERAS</p>	<p>2. REMUEVA LAS TAPAS DE LOS CONECTORES DE AGUA FRIA Y CALIENTE DE LA UNIDAD Y CONECTE LOS OTROS EXTREMOS DE LAS MANGUERAS DE SUMINISTRO DE AGUA A LOS CONECTORES DE AGUA RESPECTIVOS EN LA VALVULA MEZCLADORA DE AGUA GIRANDO LAS TUERCAS DE LOS CONECTORES HACIA LA DERECHA</p> 
---	--

DESCONECTANDO LA MANGUERA DE SUMINISTRO DE AGUA

DEBIDO A LA ALTA PRESION DE LA LLAVE AUN CUANDO ESTA CERRADA, RECOMENDAMOS DESCONECTAR LA MANGUERA, YA QUE PODRIA CAUSAR GOTE O SALPICADURA. PARA EVITARLO SIGA ESTAS INSTRUCCIONES:

1. CIERRE LA LLAVE DEL AGUA
2. ENCIENDA LA LAVADORA
3. APAGUELA LUEGO DE 5 SEGUNDOS (APROXIMADAMENTE)
4. RETIRE LAS MANGUERAS GIRANDO LAS TUERCAS DEL CONECTOR HACIA LA IZQUIERDA

SI LA LAVADORA ES USADA FRECUENTEMENTE, NO RETIRE LAS CONEXIONES PARA EVITAR POSIBLES DAÑOS.

COLOCANDO LA MANGUERA DE DRENAJE

CONECTE LA MANGUERA DE DRENAJE A LA SALIDA DE AGUA DE LA LAVADORA Y AJUSTELA CON UNA GRAMPA AJUSTABLE. COMO PUEDE DRENAR HACIA ARRIBA O HACIA ABAJO, LA MANGUERA DE DRENAJE PUEDE SER COLOCADA EN EL PISO, EL BAÑO O LA BAÑERA, SIEMPRE QUE LA ALTURA NO SEA MAYOR A 70 CM.

EL PUNTO MAS ALTO DE LA MANGUERA DE DRENAJE DEBE SER 70 – 120 CM SOBRE EL NIVEL DEL PISO, DE LO CONTRARIO LA LAVADORA NO PODRA FUNCIONAR

CORRECTAMENTE.

MODO DE EMPLEO

PREPARACION

1. CONECTE LA MANGUERA AL GRIFO DE SUMINISTRO DE AGUA.
2. ABRA EL GRIFO DE SUMINISTRO DE AGUA. NO ENCIENDA LA LAVADORA SI LA PRESION ES MENOR A 0.02MPA O MAYOR A 0.5MPA.
3. CONECTE EL CABLE DE ELECTRICIDAD EN EL TOMACORRIENTE. POR SU SEGURIDAD EL TOMACORRIENTE DEBE TENER UNA CONEXION PARA EL CABLE DE TIERRA.
4. INSERTE EL EXTREMO DE LA MANGUERA DE DRENAJE EN LA PLATAFORMA DE CONEXION. CUELGUE EL OTRO EXTREMO DE LA MANGUERA EN UN RECIPIENTE DE DRENAJE (TINA DEL BAÑO, LAVADERO, ETC.)
5. COLOQUE LA CARGA DE ROPA A LAVAR DENTRO DEL CILINDRO Y CIERRE LA TAPA. LA FUNCION DE LAVADO PUEDE CONTINUAR CON LA TAPA ABIERTA, PERO ES MEJOR CERRARLA ANTES QUE EMPIECE LA FUNCION DE SECADO (CENTRIFUGA).
6. AÑADA UNA CANTIDAD ADECUADA DE DETERGENTE EN EL DISPENSADOR COLOQUE LOS ARTICULOS A LAVAR EN EL CILINDRO INTERNO Y CIERRE LA TAPA DE LA LAVADORA. EL CICLO DE LAVADO SE PUEDE REALIZAR CON LA PUERTA ABIERTA, A DIFERENCIA DEL CICLO DE SECADO (CENTRIFUGA) EN QUE LA PUERTA DEBE ESTAR CERRADA.

INSTRUCCIONES PARA OPERAR LA LAVADORA

ENCENDIDO (POWER).

NIVEL DE AGUA (WATER LEVEL):

PRESIONE EL BOTON HASTA QUE SE ILUMINE EL NIVEL DE AGUA APROPIADO PARA LA CANTIDAD DE ROPA QUE VA A LAVAR.

TEMPERATURA DEL AGUA:

PRESIONE EL BOTON COLD PARA AGUA FRIA O HOT PARA CALIENTE. SI AMBAS LUCES SE ILUMINAN, SIGNIFICA QUE ESCOGIO AGUA TIBIA.

NOTA: EL ENJUAGUE ES SIEMPRE CON AGUA FRIA.

IMPORTANTE: PARA PODER SELECCIONAR LA TEMPERATURA, UD. DEBE CONTAR CON DOS ENTRADAS DE AGUA, UNA PARA AGUA FRIA Y OTRA PARA CALIENTE.

PROGRAMAS DE LAVADO (PROGRAM):

PRESIONE HASTA QUE SE ILUMINE EL PROGRAMA DESEADO, DE ACUERDO A LA CARGA DE ROPA QUE VAYA A LAVAR.

FUNCION (FUNCTION):

PRESIONE EL BOTON FUNCTION HASTA QUE SE ILUMINE LA FUNCION DESEADA.

INICIAR / DETENER (START/STOP):

PRESIONE EL BOTON START/STOP UNA VEZ PARA INICIAR EL FUNCIONAMIENTO. PARA DETENERLO, PRESIONE START/STOP NUEVAMENTE. SI CONTINUA FUNCIONANDO, PRESIONELO OTRA VEZ.

EL NIVEL DE AGUA PUEDE SER MODIFICADO DURANTE LA OPERACIÓN. SI DESEA UN NIVEL MAS ALTO DE AGUA, LA LAVADORA EMPEZARA A FUNCIONAR UNA VEZ QUE HAYA LLEGADO AL NIVEL DE AGUA DESEADO.

ANTES DE LAVAR

PREPARE LA CARGA DE ROPA A LAVAR. MEZCLE PIEZAS PEQUEÑAS Y GRANDES PARA OBTENER MEJORES RESULTADOS. DEPOSITE LAS PIEZAS DENTRO DEL CILINDRO. NO EMPAQUE LAS PIEZAS NI LAS ENVUELVA. LAS PIEZAS DEBEN MOVERSE LIBREMENTE DENTRO DEL AGUA PARA OBTENER MEJORES RESULTADOS. LAS PIEZAS DEBEN RODAR, HUNDIRSE Y REAPARECER.

CUANDO LAVE PIEZAS MUY GRANDES, NO LLENE MUCHO EL CILINDRO DE AGUA. EL NIVEL DEL AGUA EN LA LAVADORA NO DEBE SOBREPASAR EL NIVEL DE LA ROPA. CARGAS DE ROPA PEQUEÑAS NECESITAN MENOS AGUA. DEBE HABER SUFICIENTE AGUA EN EL CILINDRO COMO PARA QUE LAS PIEZAS SE MUEVAN LIBREMENTE. SOBRECARGAR LA LAVADORA PUEDE RESULTAR EN UN MAL LAVADO Y ENJUAGUE. LA SOBRECARGA PUEDE CAUSAR QUE LA ROPA SE ARRUGUE O QUE SE HALE.

FUNCIONES

LAS SIGUIENTES FUNCIONES DE LAVADO ESTAN PROGRAMADAS EN LA COMPUTADORA

FUNCION	REMOJO	LAVADO	ENJUAGUE	CENTRIFUGADO	FINALIZAR
HEAVY	5 Min	18 Min	2 Cycles	5 Min.	57 Min.
JEANS	5 Min	12 Min	2 Cycles	5 Min.	44 Min.
NORMAL		11 Min	1 Cycle	5.5 Min.	32Min.
GENTLE	5 Min	12 Min.	2 Cycles	3.5 Min.	43 Min.

CUENTA CON 5 MINUTOS PARA ELEGIR Y PRESIONAR EL(LOS) BOTON(ES) PARA PROGRAMAR EL MODO DE LAVADO. LUEGO PRESIONE “START/PAUSE” PARA REINICIAR LA LAVADORA. DE LO CONTRARIO, LA LAVADORA SE APAGARA AUTOMATICAMENTE.

PARA EVITAR RUIDOS MOLESTOS DURANTE EL SECADO, CIERRE LA TAPA DE LA LAVADORA.

NOTA

LAS PIEZAS DE ROPA DE COLORES QUE DESTIÑEN DEBEN SER LAVADAS POR SEPARADO PARA EVITAR QUE MANCHEN OTRAS PIEZAS.

- SI DESEA CAMBIAR EL PROGRAMA SELECCIONADO, PRESIONE EL BOTON “START/STOP”, LUEGO PRESIONE EL BOTON DEL PROGRAMA DESEADO. NUEVAMENTE PRESIONE EL BOTON “START/STOP”.
- NO AÑADA DETERGENTE PARA EL CICLO DE ENJUAGUE Y DESAGÜE.
- SI DESEA BOTAR EL AGUA DURANTE EL CICLO DE LAVADO, PRESIONE EL BOTON “START/STOP”, LUEGO PRESIONE EL BOTON DE “RINSE”. NUEVAMENTE PRESIONE EL BOTON “START/STOP”.

MANTENIMIENTO

LIMPIE REGULARMENTE LA SUPERFICIE DE SU LAVADORA CON UN PAÑO SUAVE.

LIMPIE EL CILINDRO INTERNO DE LAVADO CON UN PAÑO SUAVE, ESPECIALMENTE DESPUES DE LAVAR CON ALMIDON O CLORO.

LIMPIE EL FILTRO QUE SE ENCUENTRA EN LA VALVULA DE SUMINISTRO DE AGUA PARA PREVENIR POSIBLES OBSTRUCCIONES.

1. DESCONECTE EL ENCHUFE.
2. RETIRE LA MANGUERA DE SUMINISTRO DE AGUA Y LIMPIE EL FILTRO CON UN CEPILLO.

LIMPIANDO EL FILTRO DE PELUSAS

1. SAQUE EL FILTRO HALANDOLO HACIA ARRIBA. LAVE Y ENJUAGUE EL FILTRO CUIDADOSAMENTE. REINSTALE EL FILTRO NUEVAMENTE.

MANTENIMIENTO DE INVIERNO

1. CIERRE LA LLAVE DEL AGUA, DESCONECTE LAS MANGUERAS DE SUMINISTRO DE AGUA Y DEJELA DRENAR POR COMPLETO.
2. ACTIVE EL CICLO DE SECADO POR UN MINUTO.
3. APAGUE LA LAVADORA Y DESCONECTELA DE LA ELECTRICIDAD.

Registration Information

Thank you for purchasing this fine Avanti product. Please fill out this form and return it to the following address within 100 days from the date of purchase and receive these important benefits:
Avanti Products, A Division of The Mackle Co., Inc.
P.O.Box 520604 – Miami, Florida 33152

➤ **Protect your product:**

We will keep the model number and date of purchase of your new Avanti product on file to help you refer to this information in the event of an insurance claim such as fire or theft.

➤ **Promote better products:**

We value your input. Your responses will help us develop products designed to best meet your future needs.

------(detach here)-----

Avanti Registration Card

Name			Model #	Serial #
Address			Date Purchased	Store / Dealer Name
City	State	Zip	E-mail Address	
Area Code	Phone Number		Occupation	
Did You Purchase An Additional Warranty <input type="checkbox"/> Extended <input type="checkbox"/> None			As your Primary Residence, Do You: <input type="checkbox"/> Own <input type="checkbox"/> Rent	
Reason for Choosing This Avanti Product: Please indicate the most important factors That influenced your decision to purchase this product:			Your Age: <input type="checkbox"/> under 18 <input type="checkbox"/> 18-25 <input type="checkbox"/> 26-30 <input type="checkbox"/> 31-35 <input type="checkbox"/> 36-50 <input type="checkbox"/> over 50	
<input type="checkbox"/> Price <input type="checkbox"/> Product Features <input type="checkbox"/> Avanti Reputation <input type="checkbox"/> Product Quality <input type="checkbox"/> Salesperson Recommendation <input type="checkbox"/> Other: _____ <input type="checkbox"/> Friend / Relative Recommendation <input type="checkbox"/> Warranty <input type="checkbox"/> Other: _____			Marital Status: <input type="checkbox"/> Married <input type="checkbox"/> Single	
Comments: <hr/> <hr/>			Is This Product Used In The: <input type="checkbox"/> Home <input type="checkbox"/> Business	
			How Did You Learn About This Product: <input type="checkbox"/> Advertising <input type="checkbox"/> In-Store Demo <input type="checkbox"/> Personal Demo	

Ver. 1 – 28-03-2011

PRINTED IN CHINA